

Varenummer: 392208603054116
 Beskrivelse: Snekkegear med skridnav
 W86 L1-UFC-30-P100 B14

Mål

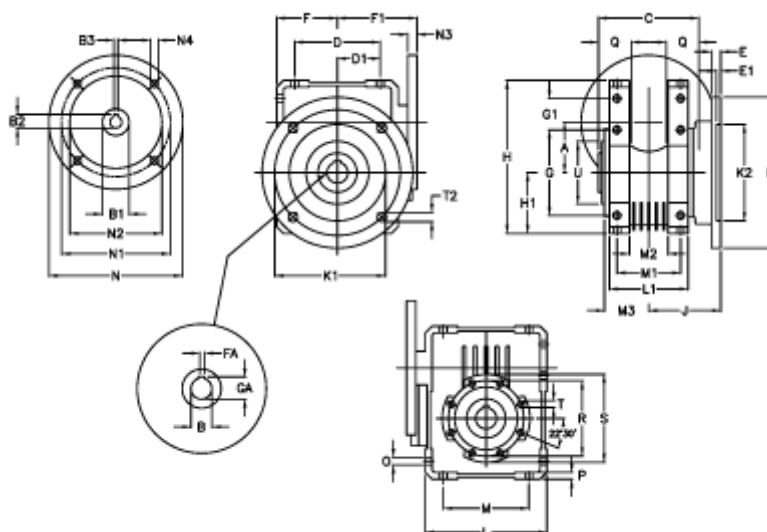

A = 86.90	E = 15	H = 245.5	M = 144	N4 = 8,5	U = 110
B = 35	E1 = 6	H1 = 100.0	M1 = 101	O = 11.5	
B1 E7 = 28	F = 100	J = 110.5	M2 = 57	P = 11	
B2 = 31.3	F1 = 136	K = 210	M3 = 64.5	Q = 45	
B3 H9 = 8	FA = 10	K1 = 176	N = 160	R = 130	
C = 140	G = 144	K2 = 152	N1 = 130	S = 150	
D = 144.0	G1 = 45.5	L = 200	N2 = 110	T = M10x18	
D1 = 72.0	GA = 38.3	L1 = 125	N3 = 10	T2 = 12.5	